



One for all . . .

MULTI TREND

TECHNOLOGY IN MOTION

MULTI TREND

Fittings that fulfil all your tilt and turn window requirements!

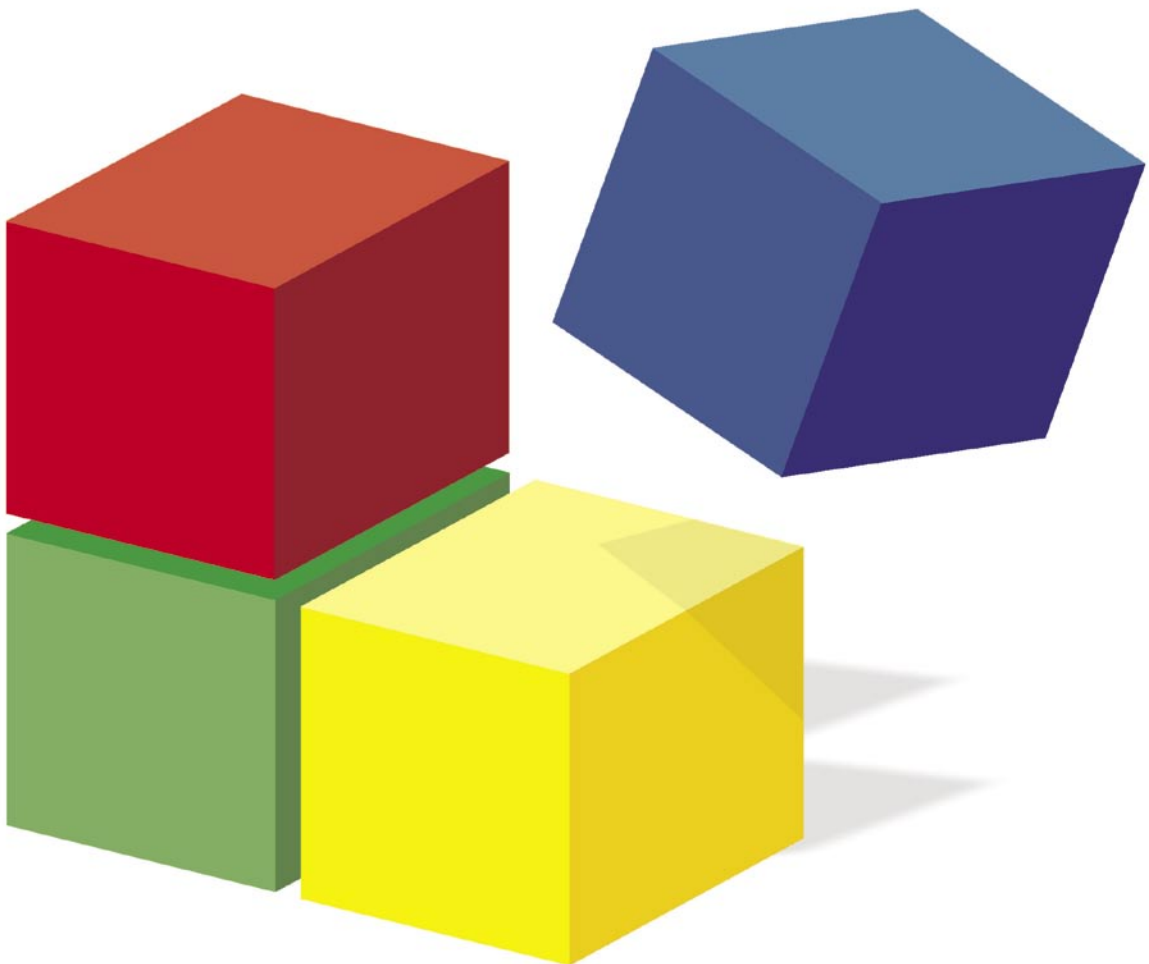

MACO MULTI TREND - *One for all...*

The modular technology of our fittings offers you all of these possibilities in one single programme. Simply: *one for all...*

- One for all . . .

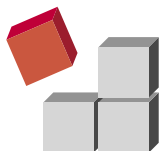

SECURE

You want secure windows . . .

- that are easy to operate
- that do not need subsequent adjustment
- from a single fittings programme with a minimum stock of components

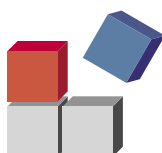

FUNCTIONAL

You want functional windows . . .

- that are both attractive and easy to operate
- that can be upgraded by adding a few additional parts
- that will make your windows stand out from the rest
- that are manufactured from one basic group of fittings

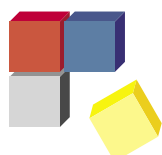

FAST

You want efficient fabrication . . .

- not only of the sash assembly but also the frame
- by using a standard range of window fittings

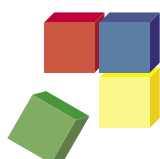

COMPATIBLE

You want just one fittings system . . .

- that enables the fabrication of many different window styles with fewer special components
- that is reliable in use resulting in longer lasting windows for your customers



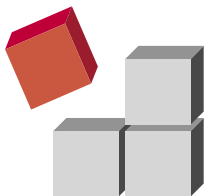

Secure

The issue of a windows burglar resistance gains more prominence every day.
You need to be able to produce windows that are both reliable and secure.

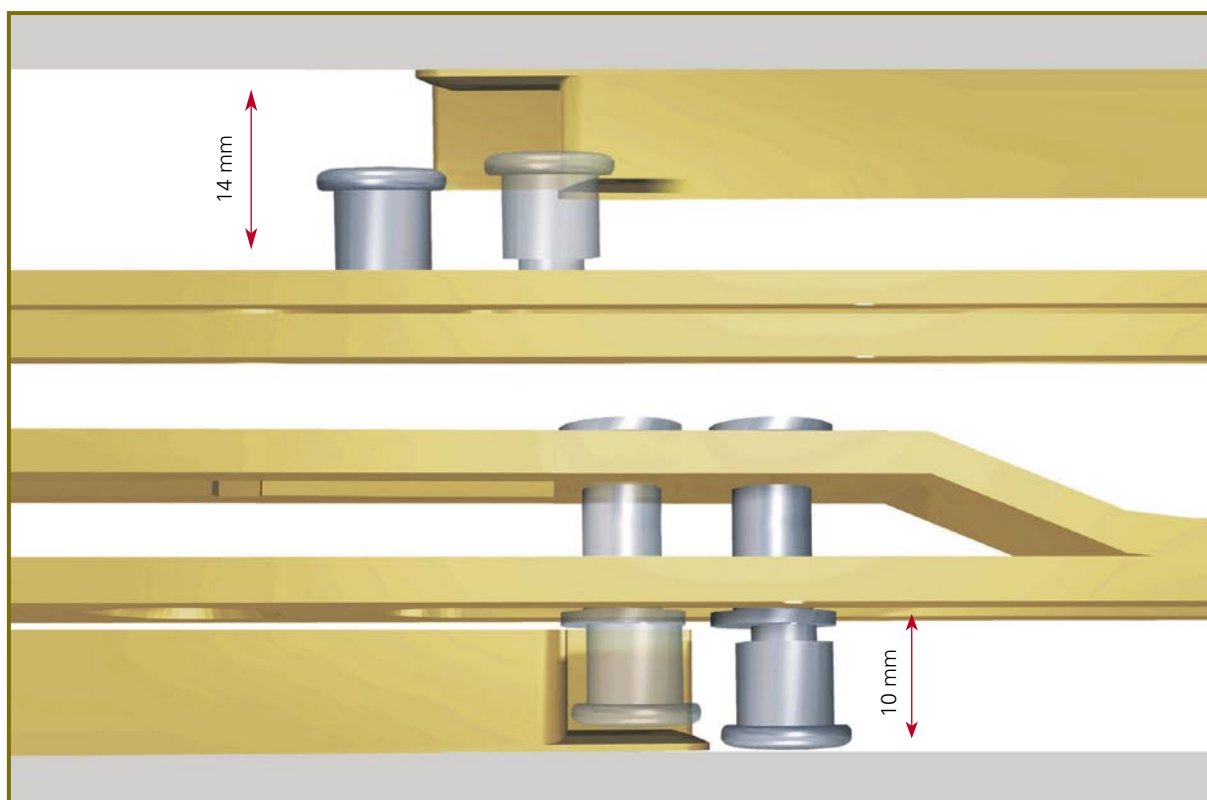

i.S. = Intelligent Security

... the most progressive way of securing and sealing a window
... saves on cost, creates satisfied customers and places you one step further ahead of the competition

- No adjustment required -
Self-adjusting to the air gap.
- Suitable for air gaps between 10 and 14 mm.
- The gasket pressure is simple to adjust.
- Smooth operation through the use of high quality materials and surface protection coatings.
- Can be used with either standard or security striker plates.
- i.S. meets all of the requirements of BS 7950: 1997.



Years of customer satisfaction through a safer function

Saving on service costs

Unique Coupling System

- Large sash weights are achievable with the unique coupling system.
- Larger area of tolerance (approx. 10 mm) when cropping fittings to size.
- No special cropping machine required.

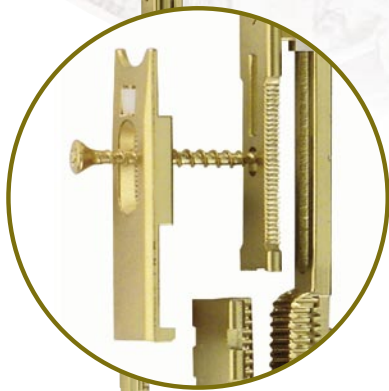

Secure Locking

- Greater travel 2 x 19 mm.
- Greater tolerance when positioning the striker plates.
- The cams travel further into the striker plate, this is particularly important for security striker plates.

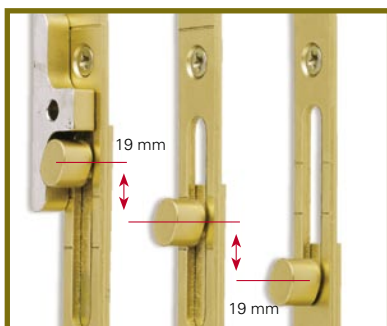

Sash Lifter

So that your customers will have easy to operate and secure windows in ten years time.

- Prevents the sash from dropping.
- Lifts the sash into the correct position with minimal effort.
- Adjustable for both left and right handed windows.
- No additional cost – the sash lifter is factory-fitted onto the drive gear.

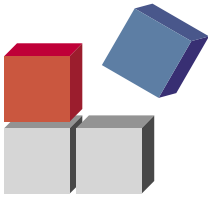

Functional

Fittings solutions that optically enhance your windows beyond comparison.
Your customers should have the feeling that they are getting something special.



Small is beautiful – Fittings that can hardly be seen

MULTI TREND TV

Partially concealed top and bottom hinges

- Smaller profile sections.
- Tilt only available in special forms.
- Opening angle up to 180°.
- For profile systems with a centre seal.

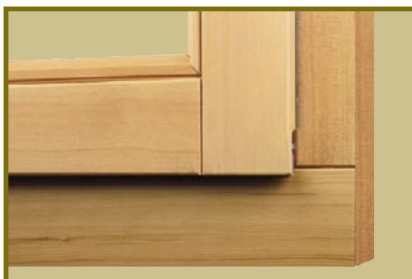

MULTI TREND VV

Fully concealed top and bottom hinges

- No drilling required even on the frame.
- Smaller profile sections.
- For standard and centre seal profile systems.



Windows with Style

For historically protected buildings as well as for that special looking window

- Rebated drive gear for windows without a fixed mullion.
- Additional part for the drive gear.



For beautiful looking windows

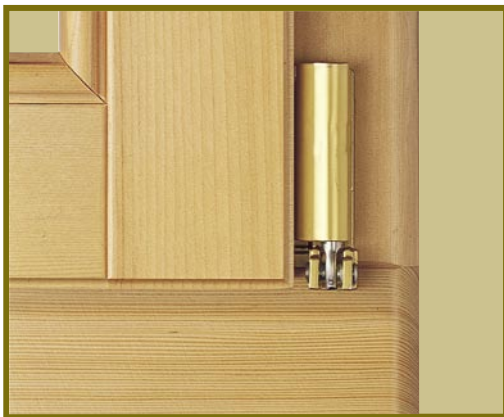

Flush Fitting – lower dimensions.



Cover cap finishes for the top and bottom hinges can match the handles.

The alternative for white or other coloured windows

Silver-look

The surface protection coating that meets the highest technical demands.



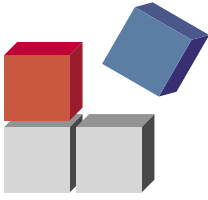

Functional

The overall function of your windows can be improved by the use of a few additional components.

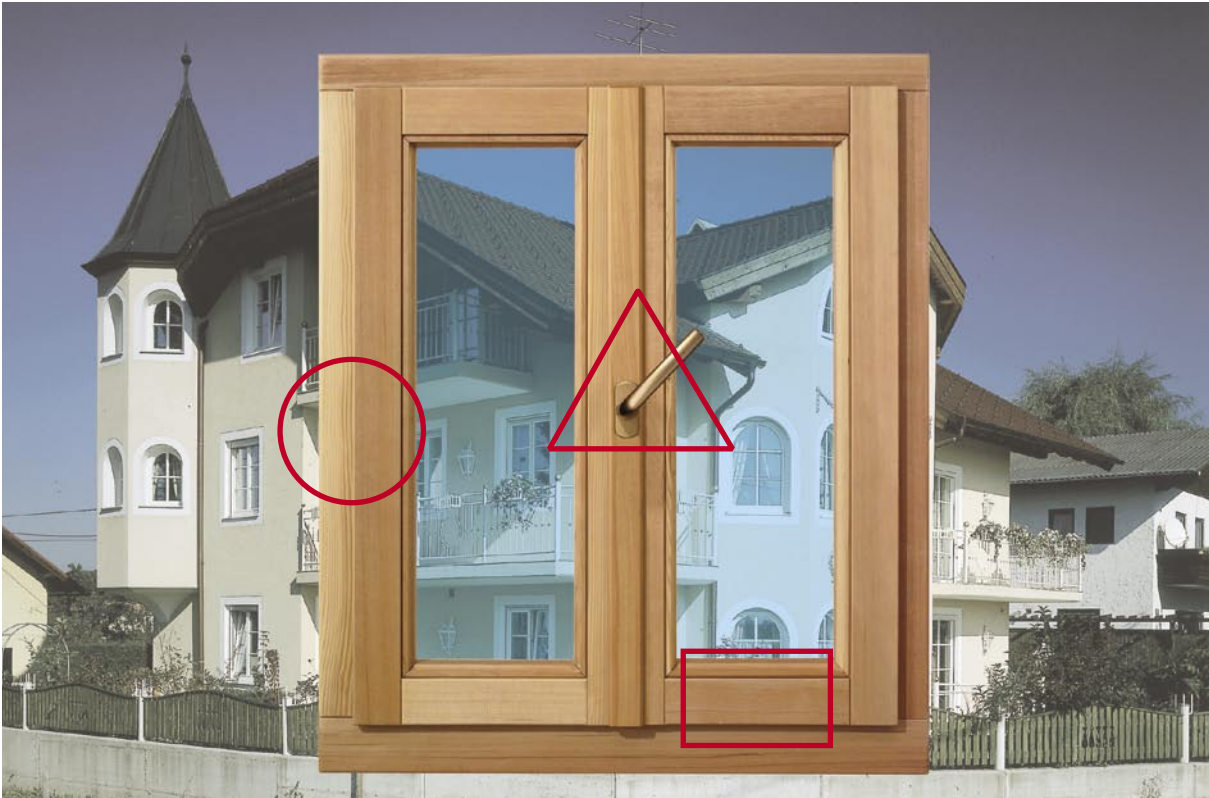

Adjustable in every direction!

This means that you are able to offer your customers a window that leaves nothing exposed.

Your customers will be satisfied!



Additional Ventilation Position **Night Vent**

- Easy to use with a simple operation.
- 10 to 13 mm night vent opening set at 45° between the two open positions.
- Built into the scissor stay, no additional components are required.
- No additional installation work.
- Additional security built into the fixed tilt position.
- Self closing scissor stays (21 mm) ensures a smooth operation.



Secure tilt position **Horizontal tilt lock bolt**

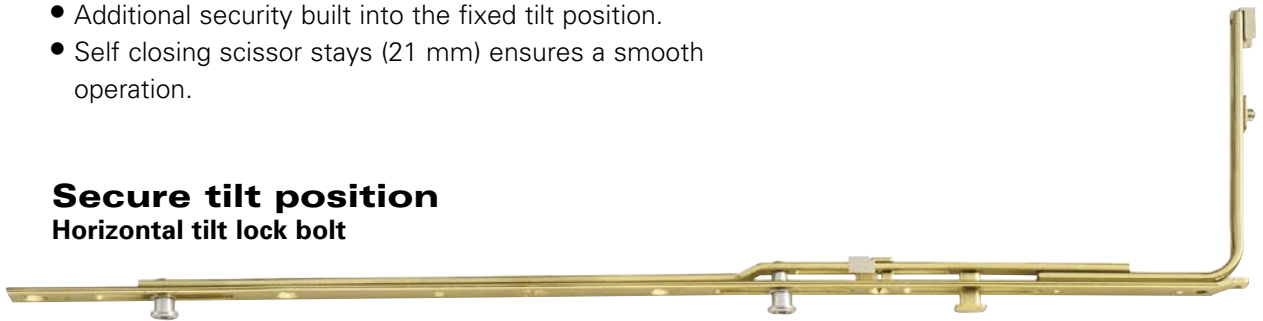

- Additional security points on the bottom of the window as standard.
- Anti-lift in the tilt position.
- Windows with a 12 mm air gap do not require any special striker plates.
- Security can be upgraded with additional mushroom strikes.
- Windows with a 4 mm air gap must be constructed with the EH centre lock and security striker plate.



Invisible and perfect **Concealed middle hinge**

- Invisible as the hinges are concealed within the air gap.
- Perfect because the hinge functions regardless of the air gap. No additional adjustment is required.
- Suitable for both left and right handed windows.

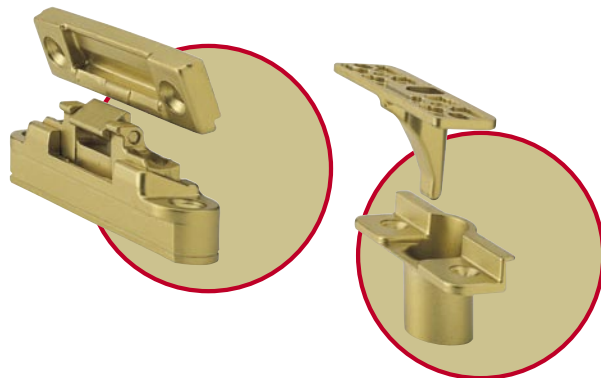

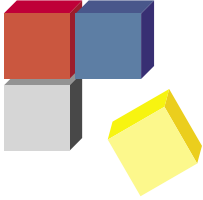

Fast

In an ever changing market new window fabrication methods are constantly being developed. As the window production times are reduced the installation of the hardware has to be able to keep up with the pace of production.

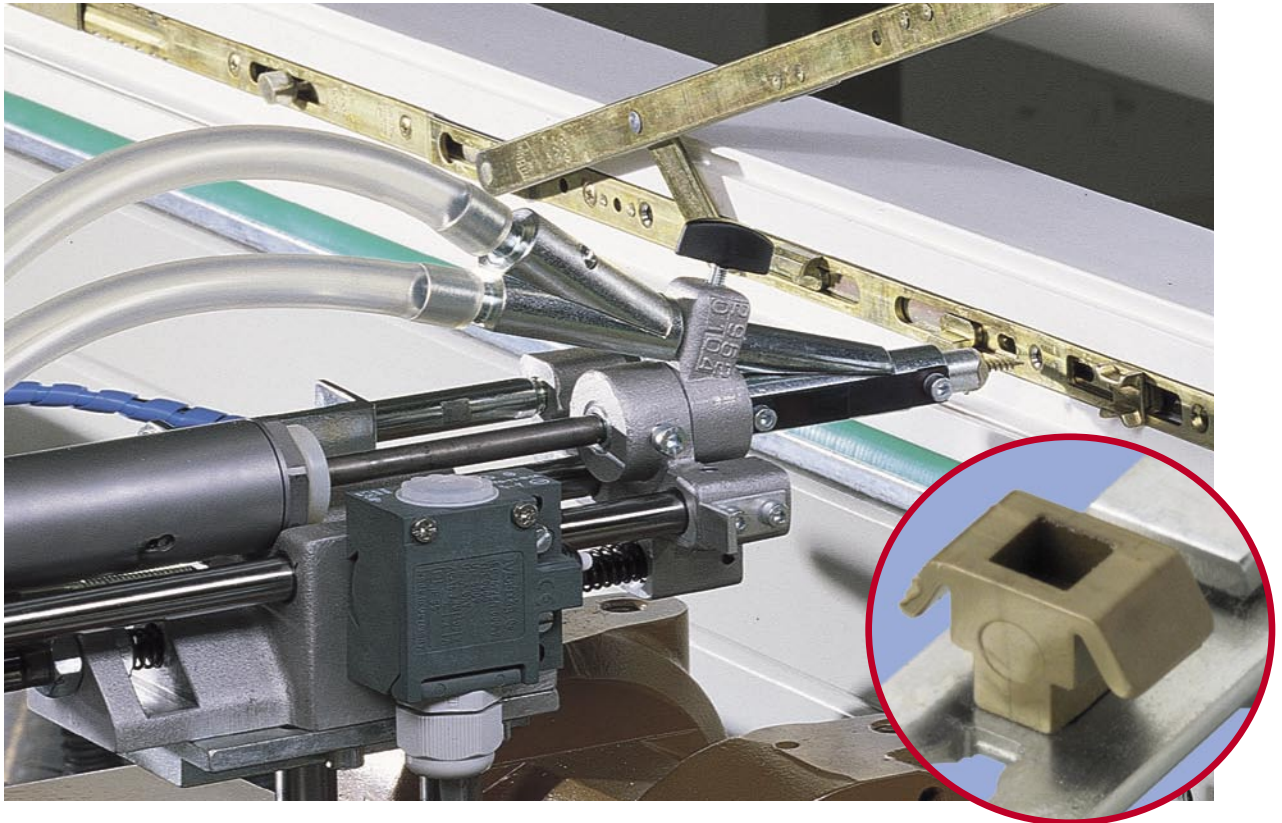

“Click-Fix” - Eurogroove clips

Click-Fix

- No special components are required.
- For automatic assembly machines.
- Advantageous for all.

	<i>Fitting Time</i>	<i>Production per shift</i>
1. Manual Assembly Manual set-up – manual screwing	App. 4 min	100 - 120
2. Semi-automatic Assembly Manual set-up – simultaneous screwing	App. 2 min	up to 200
3. Automatic Assembly Manual set-up – automatic screwing	App. 1 min	up to 400

Efficient – economical – individual!

MULTI TREND DT

Top and bottom hinges for
4 mm and 12 mm air gaps

Hinge routing is possible on individual
component lengths.

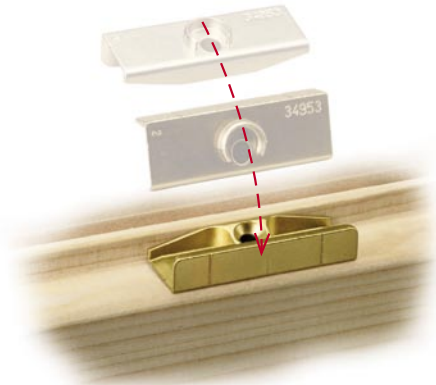
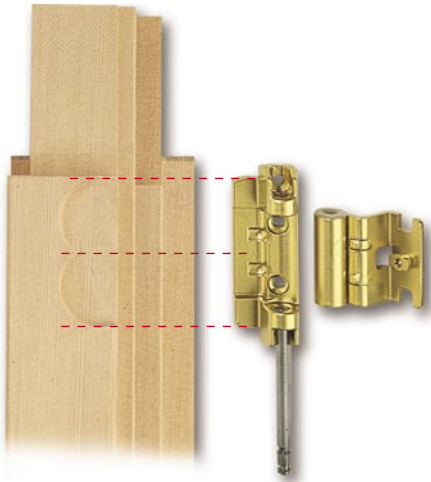

MULTI TREND AS

Face fix top and bottom hinges

- No frame routing required.
- Fast assembly – simply screw in place.
- Same hinge dimensions as the standard TREND hinges.



Striker plates with positional cams

- Can be pre-drilled on individual component lengths.
- Fast assembly – no jigs required.
- Available without screw fixing.

Same Screw Positions

- Same screw and cam positions on different striker plates.
- No resetting of machines required.

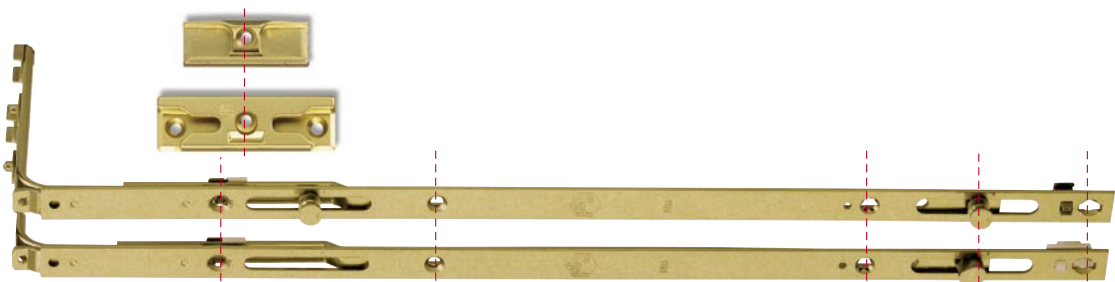

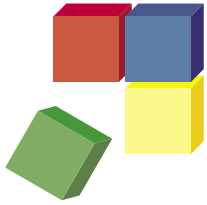

Compatible

A basic fittings programme to fabricate all types of windows. With the aid of just a few additional fittings, you can make windows that are more secure, better looking and in different shapes and styles. Advantages that you will be able to rely on for many years to come.



Special windows made to the same quality as standard windows

The sash lifter is a problem-solving component for windows, be they half round, angled, turn first or tilt first windows.

Special window styles can be produced using the standard window hinges.

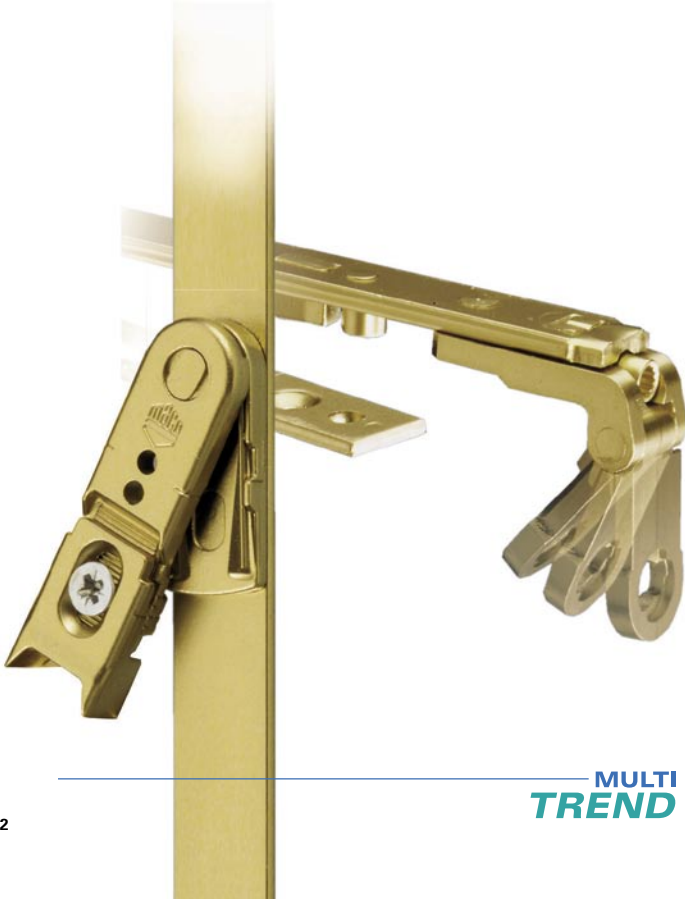

Even more Individuality is Possible!

Half Rounded and Angled Windows

Same scissor stay hinge = Same hinge dimensions as with standard windows.



Solutions for Special Constructions

The visible components remain the same as with standard windows.

Hinges for 3 sash windows



Turn only hinge



Tilt only hinge



Less Parts - More Possibilities!

Only one scissor stay

For timber and PVCU windows



Security Upgrade

By changing some of the striker plates, it is possible to turn a normal window into a burglar resistant window.

Old and New

Fittings that are more than 20 years old can be replaced by the new TREND fittings.



Sensible Accessories

Turn Locks



Opening Restrictor



Solutions for Double Sash Windows

Mullion Drive Gear

The solution for functional windows

- Easy to assemble.
- Simple to operate.
- Only two components on the sash.



Turn Only Hinge

- Compatible with the standard scissor stay hinge.
- Looks the same as a tilt and turn window.



Shootbolts

The standard window solution

The closing sash automatically locks the shootbolts.

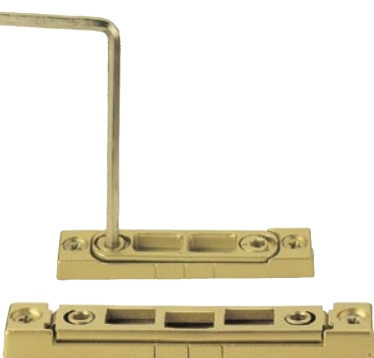

Shootbolt Striker Plates

- Adjustable gasket pressure.
- With steel insert for higher security.



**The fittings programme „MULTI TREND“
has been awarded the RAL-Mark of
Excellence.**

The mark of excellence was received in our Salzburg
factory and covers all MACO-Establishments.



Order No. 49383 — Date: May 2001

**MAYER & CO.
BESCHLÄGE GMBH**

A-5020 Salzburg
Alpenstrasse 173
Tel.: +43 (0)662 6196-0
Fax: +43 (0)662 6196-101
e-mail: maco@maco.at
<http://www.maco.at>

**MACO-BESCHLÄGE
GESELLSCHAFT M.B.H.**

D-94508 Schöllnach
Haidhof 3
Tel.: +49 (0)9903 9323-0
Fax: +49 (0)9903 9323-60
e-mail: d-maco@maco.de
<http://www.maco.de>

**MACO DOOR & WINDOW
HARDWARE (U.K.) LTD**

Eurolink Industrial Centre, Castle
Road, Sittingbourne Kent, ME10 3LY
Tel.: +44 (0)1795 433900
Fax: +44 (0)1795 433901
e-mail: maco@macouk.net
<http://www.macouk.net>

MAICO SRL

I-39015 S. Leonardo i. P.
Zona Artigianale 15
Tel.: +39 (0)473 651200
Fax: +39 (0)473 651300
e-mail: maico@maico.com
<http://www.maico.com>

MACO-BESCHLÄGE B.V.

NL-7021 BN Zelhem
Stikkenweg 60
Tel.: +31 (0)314 622627
Fax: +31 (0)314 623649
e-mail: info@maco-nl.nl
<http://www.maco-europe.com>

**MACO POLSKA
SP. Z O.O.**

PL 44-137 Czekanów k/Gliwicz
Ul. Gliwicka 1a
Tel.: +48 (0)32 3050904
Fax: +48 (0)32 3050901
e-mail: maco@demo.pl
<http://www.maco-europe.com>